

POLYCARBONATE
SHEETS



ELYSOL

ELYPPLAST



FIBERGLASS
LAMINATES



POLYCARBONATE SHEETS



Corrugated and ribbed sheets with exceptional transparency.

Compact polycarbonate, thermoplastic product, is lightweight and completely transparent, similar to glass and provides an elegant aesthetic effect. The outer surface is UV-protected, impact resistant and has a good performance of fire reaction.







Polycarbonate sheets are used in industrial and agricultural applications, both as roofing and vertical curtain walls, and are often used in the field of interior design and architecture.



CORRUGATED STRAIGHT SHEETS



RIBBED STRAIGHT SHEETS

-  Full transparency
-  Lightness
-  UV Resistance
-  Fire reaction
-  High resilience
-  Easy handling

ELYPLAST®

FIBERGLASS LAMINATES

Translucent or opaque, corrugated or ribbed sheets and rolls, with maximum strength.

Sheets and rolls produced by continuous lamination combining glass fiber reinforcement with polyester resin.

This thermosetting product is available in translucent or opaque versions and is lightweight, easy to work, durable and has high mechanical strength. Ideal for use in industrial, residential and agricultural buildings.

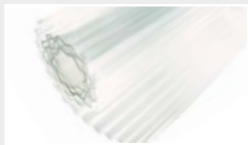

FLAT AND CORRUGATED ROLLS



STRAIGHT TRANSLUCENT CORRUGATED AND RIBBED SHEETS



STRAIGHT MATT CORRUGATED AND RIBBED SHEETS



Mechanical resistance



Low thermal linear expansion



Resistance to atmospheric agents



Corrosion resistance



Easy handling



High durability

POLYCARBONATE SHEETS

Full transparency for excellent light transmission, both in agricultural and industrial buildings, also suitable for residential applications, with the benefit of resistance to impact, weathering and good fire reaction.

ELYSOL

APPLICATIONS:



ELYSOL APPLICATIONS

Elysol is a very versatile, lightweight and transparent product that provides natural lighting wherever it is installed, either in the roof or curtain walls.

Thanks to its transparency and impact resistance, Elysol is widely used in industrial and agricultural buildings to create roofs and curtain walls, skylights, greenhouses, porticoes and canopies.



ELYSOL: PRODUCT CHARACTERISTICS

Elysol compact corrugated and ribbed polycarbonate sheets are UV-protected on one or two sides and are lightweight, highly resilient, versatile, with excellent weather resistance; they have good performance of fire reaction and an exceptional capacity to transmit light.

Lightweight and easy to handle, Elysol can also be easily installed on lightweight structures, delivering high pressure and suction load values.

Its transparency allows natural light to enter the indoor environment, providing a high level of comfort.

Elysol is highly resistant to accidental impacts.

ELYSOL: TRANSPARENT OR OPAL FINISH

Elysol corrugated and ribbed compact polycarbonate sheets come in completely transparent and aesthetically pleasing versions.

These sheets maximise the transmission of sunlight into buildings, which is essential for the growth of certain types of plants in greenhouses. They are ideal for transparent areas in agricultural, industrial or residential buildings.

Elysol compact polycarbonate sheets are also available in opal white, which allows 50% light transmission, and in opaque white, which is completely opaque.

The opal white sheets are ideal for roof and curtain wall applications that require controlled light transmission, such as horticulture.

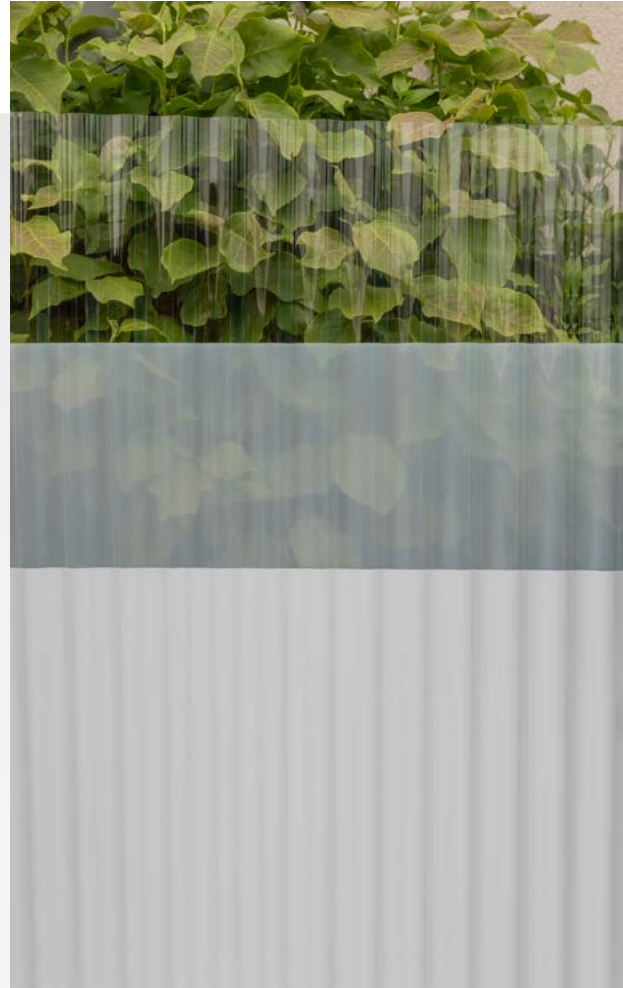

■ TRANSPARENT CORRUGATED SHEETS



■ OPAL WHITE CORRUGATED SHEETS



■ OPAQUE WHITE CORRUGATED SHEETS

TECHNICAL SPECIFICATION	VALUE	TEST METHOD
Density	1,2 kg/dm ³	internal method
Temperature range	-40°C ÷ 120°C	internal method
Fire reaction	Class B-s1, d0	EN 13501-1
Light transmission	Neutral: 90% ±5% (thickness 1mm)	EN 13468-1
UV protection	Weathered surface protected with a co-extruded anti-UV layer (optional on both sides).	
Coefficient thermal conductivity (λ)	0,21 W/mK	internal method
Coefficient heat transmission (U)	210 W/m ² K (thickness 1 mm)	internal method
Min. bending radius	10 m	internal method
Tensile strength	65 MPa	EN ISO 527-2
Yield strength	60 MPa	EN ISO 527-2
Tensile modulus	2350 MPa	EN ISO 527-2
Coefficient of thermal linear expansion	65 x 10 ⁻⁶ °C ⁻¹	EN 1013
Waterproof permeability	3,8 x 10 ⁻⁵ mg (m h Pa)	EN 1013

CE mark in compliance with the European Regulation 305/2011/CE, norm EN1013. System VVCP:3.

Dimensional and qualitative tolerances

Refer to norms EN 1013

Resistance to chemical agents

Polycarbonate sheets are not affected by the action of the following acids, in the solutions indicated depending on the concentration and the test temperature of 25°C:

Diesel fuel	Hydrochloric acid => 5%
Kerosene	Sulphoric acid => 15%
Ammonium chloride	Ethyl alcohol => 90%

PACKAGING, HANDLING AND STORAGE

Elysol sheets are palletised and loaded on transport vehicles with the use of lifts. When unloading, the product must be handled with suitable lifting equipment, avoiding accidental impacts and abrasions that could compromise the aesthetic and functional characteristics.

If stored outdoors, the sheets must be covered with tarpaulins to protect them from the sun and rain.



ELYSOL

ELYSOL LAYING



Watch the video:

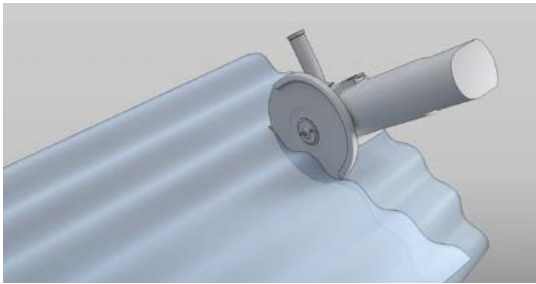

CUTTING THE SHEETS

The Elysol sheets can be cut using a high-speed circular saw with small teeth or a jigsaw or shears, making sure to support the sheet near the cutting point and to remove any dust generated.

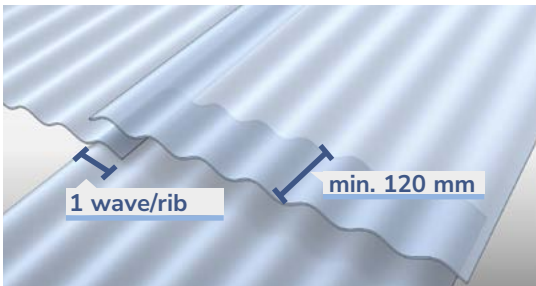

OVERLAPPING THE SHEETS

The laying sequence is always from bottom to top and in the opposite direction to the prevailing winds. Allow for an overlap of one wave or one rib on the sides, and a minimum distance of 120 mm along the length.

Always lay the UV-protected side towards the outside.

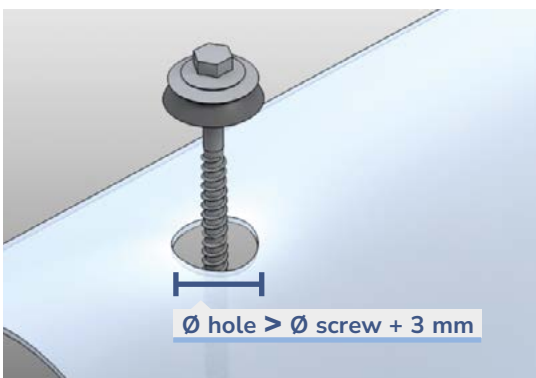

FIXING THE SHEETS

The Elysol sheets must be fixed at the top of the wave or rib using the screws and gaskets supplied. To correctly fix the sheets, drill a **hole that is 3 mm larger in diameter than the screw**, in order to compensate for thermal expansion of the sheet. To seal the sheets, only use neutral silicone; to clean, use water and neutral soap.

The polycarbonate sheets cannot be walked on.





CORRUGATED STRAIGHT SHEETS SOME PROFILES

S076

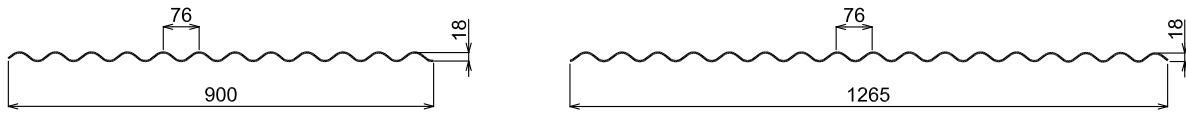

S177

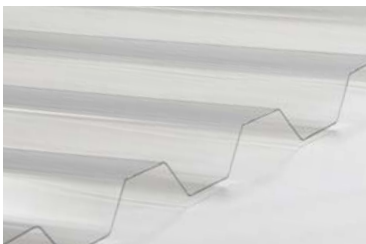
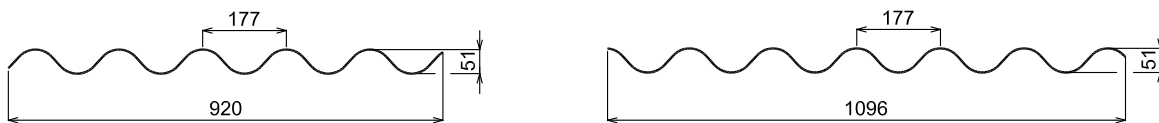

RIBBED STRAIGHT SHEETS SOME PROFILES

S215

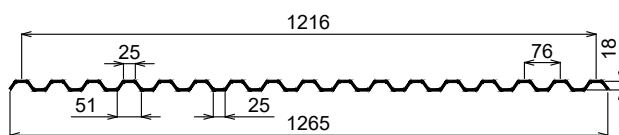

S454

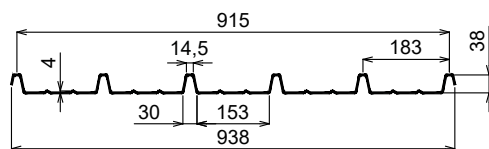

S659

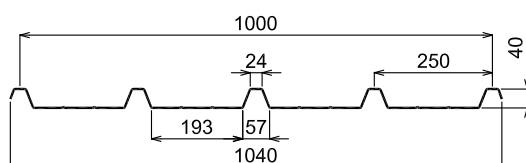

FIBERGLASS LAMINATES IN SHEETS AND ROLLS

Elyplast fibreglass laminates in sheets and rolls have extreme mechanical strength and a very low coefficient of thermal expansion to ensure stability and durability. They are highly resistant to atmospheric and chemical agents, easy to handle and work, and can be used for a variety of applications in industrial, residential and agricultural buildings.

APPLICATIONS:



ELYPLAST

ELYPLAST APPLICATIONS

Elyplast is a lightweight and highly resistant product, ideal for roofs, skylights and curtain walls for industrial and agricultural buildings, livestock farms, greenhouses, mushroom houses, tunnels and covered walkways, porticoes, projecting roofs, windows and DIY projects.

Thanks to its resistance to corrosion, it can also be used in water purification plants, in the roofing of composting plants, zinc works and tanneries and for the construction of cooling towers.



Agrigento (Italy), Valle dei Templi, Elyplast covering.

ELYPLAST: PRODUCT CHARACTERISTICS

Elyplast sheets and rolls are continuous lamination products with a stratification of polyester resin and fibreglass reinforcement (GRP). The standard version of Elyplast has an orthophthalic resin base, stabilised against UV rays and with low shrinkage.

Elyplast is available in translucent or opaque versions and is lightweight, easy to work, durable and has high mechanical strength. It is ideal for prevalent use in industrial and agricultural buildings.



TECHNICAL SPECIFICATION	VALUE	TEST METHOD
Density	1,4 kg/dm ³	internal method
Temperature range	-40°C + 120°C	internal method
Fire reaction	Standard GRP (Glassfibre Reinforced Polyester) laminates do not drip. Class (estimated): F	EN 13501 - 1
Light trasmission	Clear translucent 82%, light opal 56%, milky white 35% (1,0 mm thickness)	EN 1013
Coefficient thermal conductivity (λ)	0,22 W/mK	internal method
Coefficient heat trasmission (U)	220 W/m ² K (1 mm)	λ/d (d= sheet thickness in m)
Tensile strenght	55 ÷ 60 MPa	EN ISO 527- 4/2/2
Tensile modulus	5500 ÷ 6500 MPa	EN ISO 527- 4/2/2
Coefficient of thermal linear expansion	$3 \times 10^{-5} \text{ }^\circ\text{C}^{-1}$	EN 1013
Water vapor permeability	$1,5 \times 10^{-5} \text{ mg (mhPa)}$	EN 1013
Flexural rigidity	500 N/mm	$(E \cdot h^{3/12})$ 1 mm
Hardness Barcol	55 ÷ 60	EN 59
Water absorption	$\leq 1\%$	internal method

CE mark in compliance with the European Regulation 305/2011/CE, norm EN1013. System VVCP:4.

Dimensional and qualitative tolerances

Refers to norms EN 1013

Resistance to chemical agents

The fiberglass laminates are not affected by the action of the following acids, in the solutions indicated depending on the concentration and the test temperature ranging from 30 to 50°C:

Acetic acid ==> 5%	Sulphoric acid ==> 30%
Hydrochloric acid ==> 10%	Ethyl alcohol ==> 95%
Nitric acid ==> 10%	Benzol ==> 30%

PACKAGING, HANDLING AND STORAGE

Elyplast rolls are palletised; the rolls are individually packaged with cardboard and protective stretch film and travel freely inside the transport vehicle or arranged on pallets. When unloading, the product must be handled with suitable lifting equipment (otherwise it must be unloaded by hand, one sheet at a time), avoiding accidental impacts and abrasions that could compromise its aesthetic and functional characteristics.

If the material is stored outdoors, it must be protected from the sun and rain by tarpaulins.

ELYPLAST

FIBERGLASS ROLLS

ELYPLAST

A product that has been successful for decades, used worldwide for many applications in the industrial, agricultural and DIY sectors. Easy installation and simple handling make Elyplast fibreglass rolls the ideal product for the construction of greenhouse roofs and side curtain walls.

APPLICATIONS:



Agricultural buildings



Farms



Industrial buildings



Greenhouses



Tunnels / covered walkways



Lamellar filters for water treatment



DIY



APPLICATIONS & CHARACTERISTICS ELYPLAST ROLLS

The ease of installation and handling of Elyplast fiberglass rolls makes them ideal for the construction of greenhouse roofs and side curtain walls. They are also suitable for use as an awning on typical prefabricated buildings.

Elyplast rolls can be quickly and easily cut to size with standard tools. Available flat or corrugated, in translucent or opaque finishing, to meet a wide range of construction requirements.



CORRUGATED ROLLS

Corrugated rolls having a profile similar to the zinc-coated sheets.

Used for roofings, curtain walls, fencings, canopies, etc.

The wide range of height and length dimensions allows for continuous solution, reducing the number of overlaps.



TECHNICAL SPECIFICATIONS	VALUES
Width Length	from 0,5 to 3 m max. 40 m
Components	products made of standard resins (special resins on request)
Colours	clear translucent, green, (others on request)



FLAT ROLLS

Laminate products of various thicknesses, height and length dimensions, are particularly well suited to walls. They may be utilised to realize doors, windows and vertical closures in general, in cases where durability is essential and to prevent against breakage and accidents.

It can be used with great effect in the industrial sector to manufacture panels.



TECHNICAL SPECIFICATIONS	VALUES
Width Length	from 0,5 a 3 m max 40 m
Components	products made of standard resins (special resins on request)
Colours	clear translucent, green (others on request)

RIDGES

The Elyplast fiberglass laminate range comes complete with purpose-built finishing elements (ridges), available in various colors in both the standard version (R105) and the opaque Elyonda line (R104 and R107).



R104

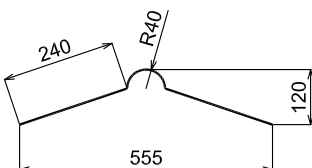

R105

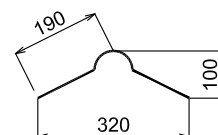

FIBERGLASS STRAIGHT SHEETS

A wide array of corrugated and ribbed profiles to meet the most varied roofing and curtain walling requirements and to create an environment with a pleasant distribution of light.

APPLICATIONS:

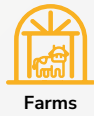

APPLICATIONS & CHARACTERISTICS ELYPLAST SHEETS

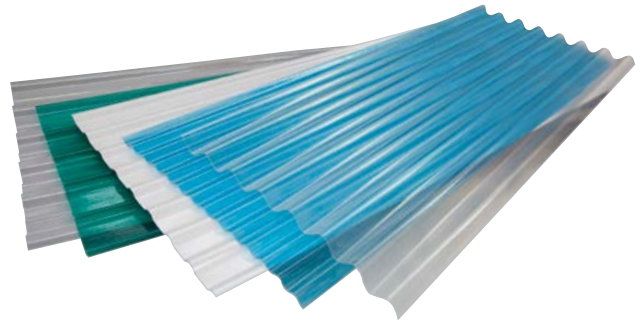

Elyplast product line contains a wide range of profiles which reflects those of the sheets most frequently used for roofings, translucent walls and discontinuous skylights on pitched roofs.

Elyplast corrugated sheets can be curved within certain limits during installation, especially when roofs are not flat (circular, semi-circular, etc.), as in the case of tunnel greenhouses.

The sheets can have a length that corresponds to that of the roof pitch; otherwise, it is necessary to use overlapping.

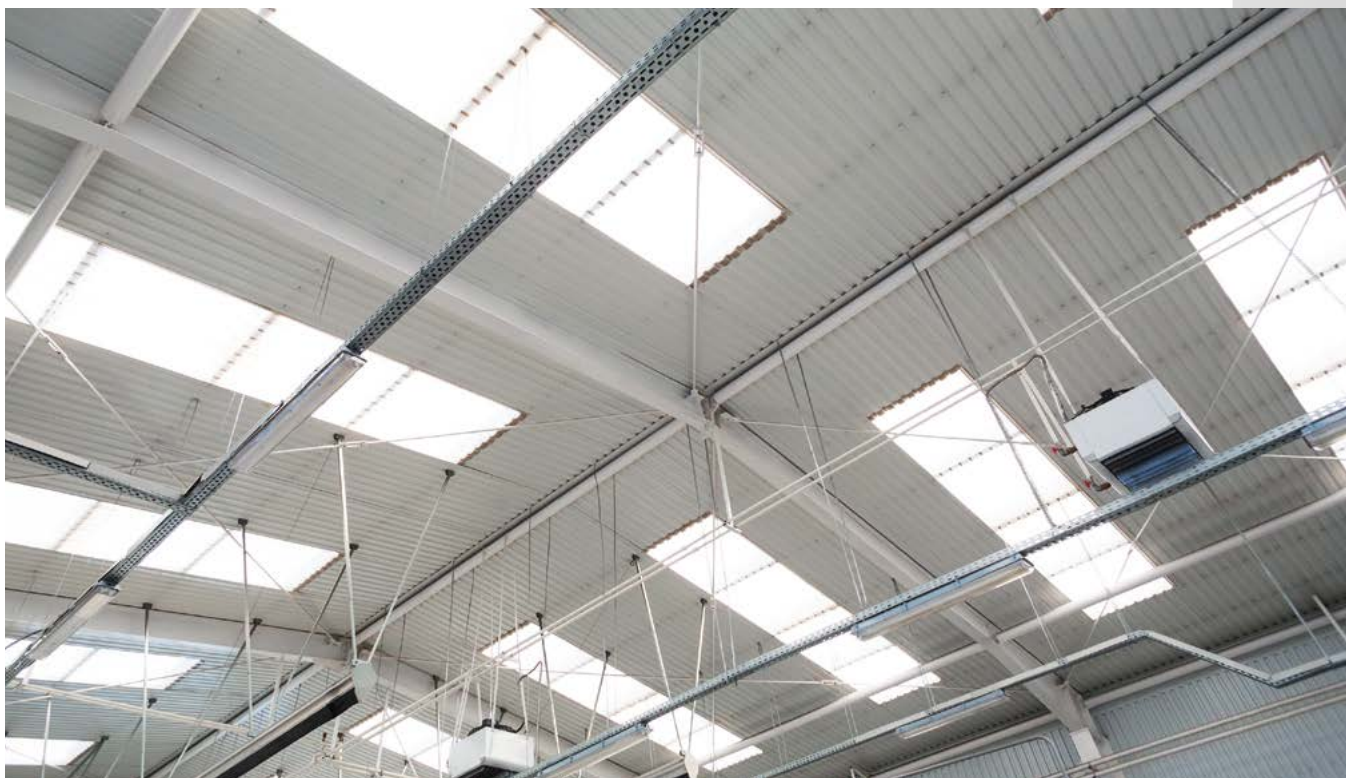
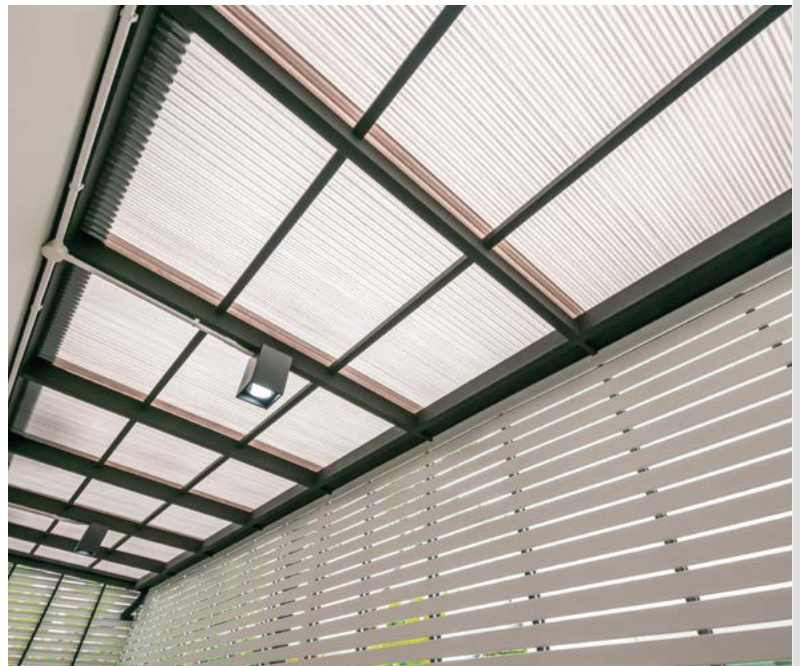



CORRUGATED STRAIGHT SHEETS SOME PROFILES

RN076

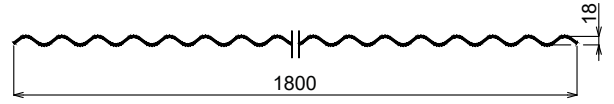
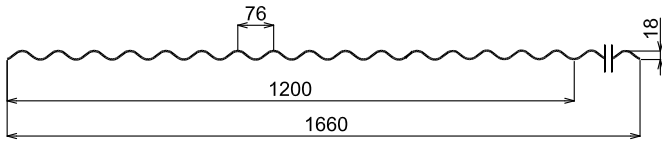

RN177

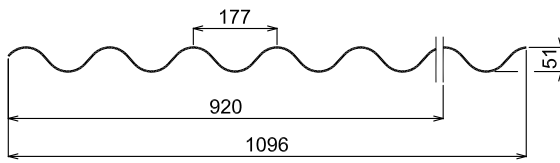

RN146

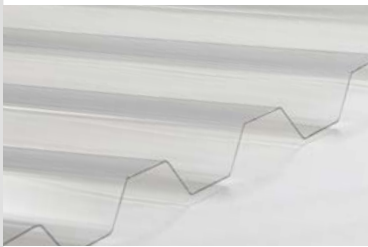
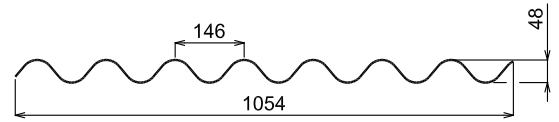

RIBBED STRAIGHT SHEETS SOME PROFILES

RN117

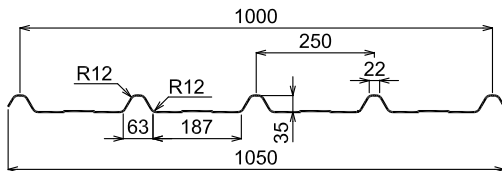

RN274

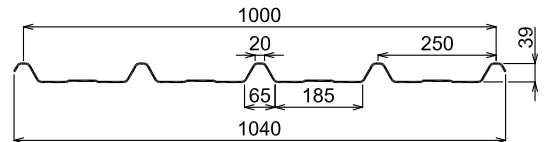

RN118

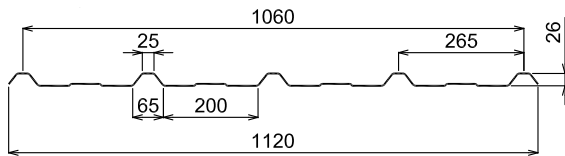

RN215

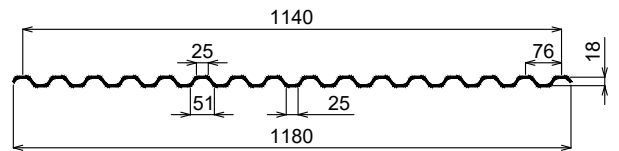

RN625

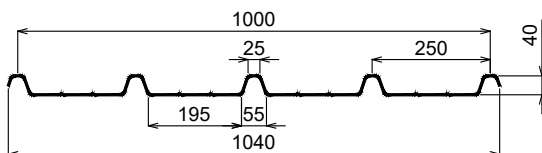

RN454

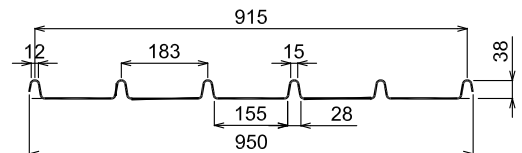

ELYCLEAR

THE NEW EMBOSSED TRANSLUCENT GRP SHEET

A new, innovative fiberglass sheet that gives the ambient a completely new light and comfort. The upper side is uv-protected; the lower side is embossed finished and ensures a uniform light diffusion, for a better visual comfort. Elyclear has a high mechanical and chemical resistance. A very good aesthetic apperance, with no glass fibers visible.



APPLICATIONS:

- 
 Agricultural buildings
- 
 Industrial buildings
- 
 Greenhouses
- 
 Skylights
- 
 DIY

RN076

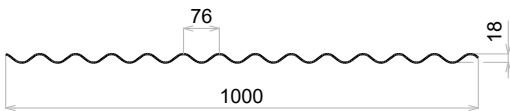

LAYING OF ELYPLAST STRAIGHT SHEETS



Watch the video:

- The laying of sheets is from the bottom towards the top and perpendicular to the gutter line.
- Lay sheets longitudinally: opposite to the direction of the main winds.
- Head overlap: in the case of gradient lower than 7% it is preferable to use sheets equal in length to pitch width (up to 6m), so as to prevent water from flowing back inside in case of heavy rain and of strong wind in the direction of the ridge line. When transversal or head overlaps are foreseen, their length must be that indicated in the table, appropriate to the width of the pitch up to 15 m.
- Longitudinal overlap: in the case of fiber-cement, it is recommended to allow for the overlap of one wave and a quarter; in case of metal, allow for the overlap of at least a whole wave.
- Disposal of rain water on low gradient slopes: for slopes between 7% and 15%, the disposal of water may not be ensured if the height of the wave of the corrugated or ribbed sheets is not enough high. In this case it is advisable to use profiles with higher waves.
- Thermal expansion: the surface temperature may range from summer to winter by more than 50°C; to compensate the increase of length for sheets longer than 3 mt, it is advisable to provide for the clearance of the fixing hole.

GRADIENT (%)	HEAD OVERLAP (mm)
7<P<10	250
10<P<15	230
15<P	200



FIBERGLASS CURVED SHEETS

Curved and ribbed sheets to meet any roofing requirement, thanks to their compatibility with almost all curved sheets and panels available in the roofing sector.

APPLICATIONS:



Agricultural buildings



Farms



Industrial buildings

RIBBED CURVED SHEETS

The ribbed curved sheets are available in two different bending radii and ribbing profiles. These sheets are used to create roofs, skylights, translucent covered passages coupled with different types of supporting structures (metal, reinforced concrete, wood).



C494

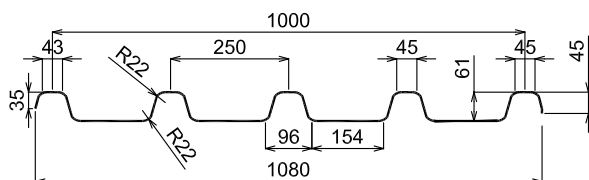

C496

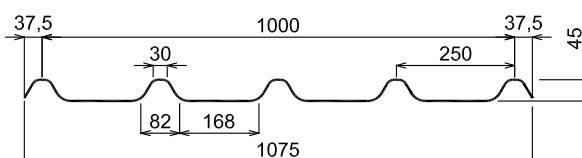

OPAQUE FIBERGLASS SHEETS FOR AGRICULTURAL AND INDUSTRIAL USE

ELYONDA

Total opacity and maximum resistance for the construction of roofs, vertical curtain walls and false ceilings for agricultural, industrial and farm buildings.

APPLICATIONS:



Agricultural buildings



Farms



Industrial buildings





APPLICATIONS & CHARACTERISTICS

ELYONDA

Elyonda are corrugated or ribbed opaque sheets made of polyester resin reinforced with fibreglass and filled with alumina.

The Elyonda sheets are made using exclusively isophthalic resin with an anti-UV gelcoat applied on the surface exposed to atmospheric agents, resulting in a high degree of resistance to abrasion. The Elyonda sheets are light, resistant and durable and can meet any requirement of roofs, vertical curtain walls and false ceilings, allowing the widest design freedom when working on both new structures or on partial or complete renovations.



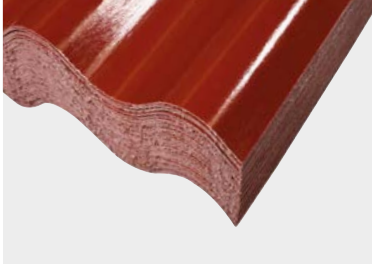

ELYONDA CORRUGATED SHEETS

SOME PROFILES

R146

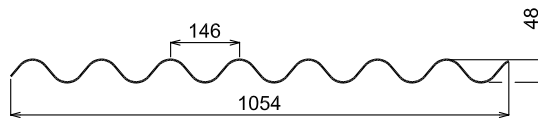

R177

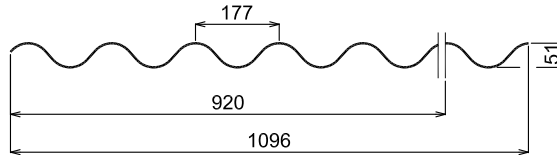

ELYONDA: MAIN ADVANTAGES

- 100% opaque
- Sheets filled with alumina to improve the fire reaction performance
- Outside surface gelcoat protected
- High resistance to chemical agents
- Easier handling compared to metal sheets
- Low noise transmission when raining

TECHNICAL SPECIFICATIONS	VALUES	
Opacity	100% opaque	
Weight	3,2 - 3,5 - 3,8 - 4,2 kg/m ²	
Temperature range	- 60 °C + 140 °C	
Fire reaction	Elyonda ≥ 4,2 kg/m ² C S3 D0 Broof(t1)	EN 13501-1 EN 13501-5
	M2/M3	NF P.92.507
Coefficient of linear thermal expansion	2-2,5 x 10 ⁻⁵ C ⁻¹	
Water absorption	0,2% after 48 hours of immersion	
Colours	grey (light and dark), green, brick red (others on request)	

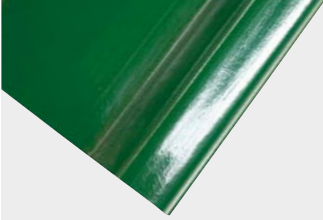

ELYONDA RIBBED SHEETS SOME PROFILES

R153

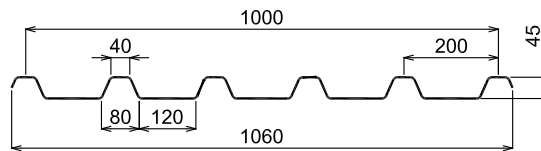

R627

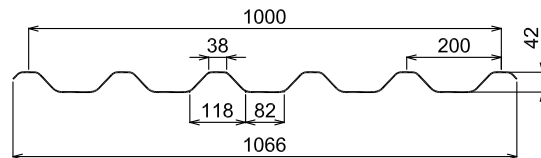

SURFACE PROTECTION FOR ELYPLAST

GELCOAT

Elyplast sheets can be protected by a selected isophthalic resin (gelcoat) applied on the outside surface during the lamination phase. Gelcoat offers a stable surface which is resistant to atmospheric pollutants, is shock resistant and provides the laminate its characteristics of retaining its structural and functional integrity over time.

STANDARD POLYESTER FILM

Elyplast sheets can be protected by a special polyester film, which acts as a surface protection for the fiberglass laminate, giving a high level of resistance to weather abrasion and limiting the rising of the glass fiber.

POLYESTER FILM ANTI-UV

Elyplast sheets can be protected by an anti-UV polyester film, which is particularly resistant against UV, in order to make the protected sheet retaining its original characteristics over time, avoiding surface abrasion and slowing down the process of colour fading.

OPAQUE FIBERGLASS SHEET “DIY”

Brightly coloured sheets in small sizes for easy handling, ideal for all DIY activities and for constructing pergolas, projected roofs and tool sheds.

ELYONDA^{LT}
XLT

APPLICATIONS:



DIY



ELYONDA LT

ELYONDA XLT

APPLICATIONS & CHARACTERISTICS

ELYONDA LT/XLT

Opaque fibreglass sheets with uv-protection, that creates an armour on the surface, providing high resistance to atmospheric abrasion.

Main applications:

- PERGOLAS, VERANDA
- ROOFS
- GARDENING
- HOBBY TOOL
- SHEDS



COLOUR RANGE:

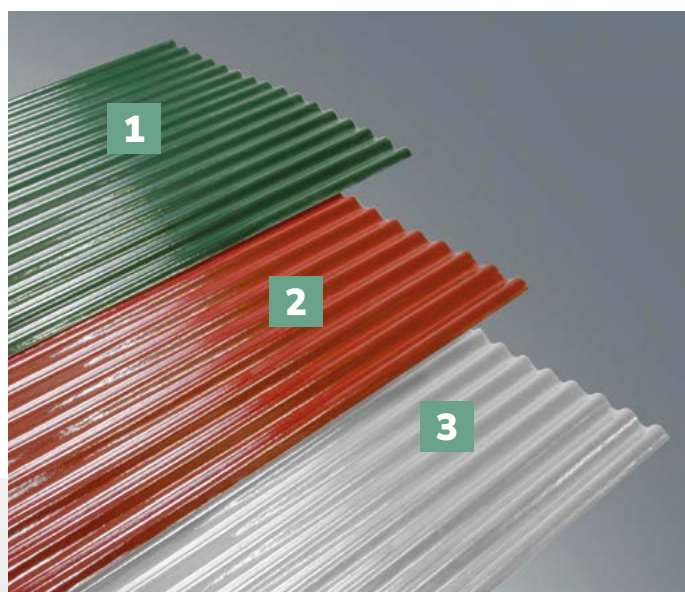

- 1** Green
- 2** Brick red
- 3** Light grey

Others colours on request.

LAYING OF ELYONDA LT / XLT

- Elyonda LT/XLT sheets are installed starting from the gutter to the ridge, overlapping by one or two waves for at least 200 mm of the head (increasing to 250 mm for slopes of less than 10%).
- The hole for the fixing screws should be made with a drill whose diameter is at least 2 mm larger than the screw, in order to allow for any thermal expansion. The sheets can be laid on wood, metal or concrete, using the appropriate fixing devices.
- It is important to use gaskets and washers large enough to cover the hole. The Elyonda LT and Elyonda XLT fiberglass sheets cannot be walked on.

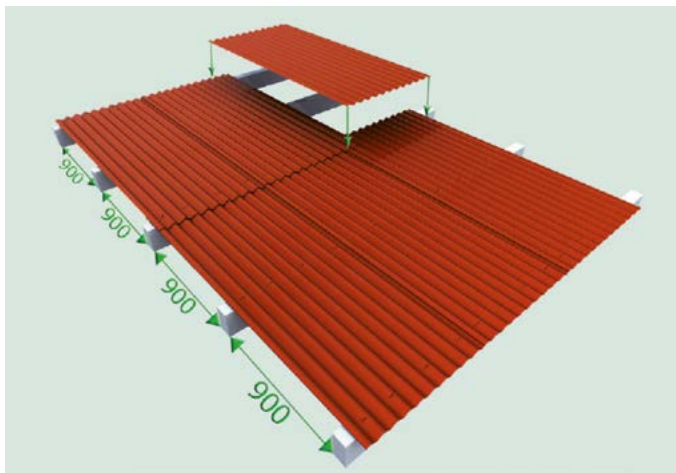

RN076

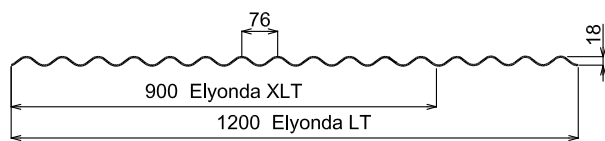

TECHNICAL SPECIFICATIONS	ELYONDA LT	ELYONDA XLT
Weight	1,30 kg/m ²	1,00 kg/m ²
Width	1.200 mm	900 mm
Length	2.000 - 3.000 mm	2.000 - 3.000 mm

ACCESSORIES

Octagonal washers



Expanded corrugated fillers



Spacers



Wooden netting



Cap nuts



Self-tapping nails with washer



Bars



Washers



Expanded square corrugated netting



Self-tapping screws



Gaskets



Coach screws



EXPLAST

SERVICE INFORMATION

Recommendations

- The empty spaces in the roofing to be covered with transparent or opaque materials must be permanently protected by using a metallic net in accordance with the test required by UNI 494.
- Do not lay the sheets in case of strong wind.
- Do not treat the surfaces with unsuitable products (e.g.: paint remover, acids, solvents, strong bases).
- Do not expose to flames.
- Do not walk on the sheets without a weight distribution board.

Snow and wind loads: the design takes into account loads resulting from snow and wind depending on the area and altitude. The test consists of ascertaining that the sheet (corrugated or ribbed) selected for the roofing in a particular area at a particular altitude is properly resistant. For loading capacity of the various profiles refer to the appropriate table.



Brianza Plastica SpA
Via Rivera, 50 - 20841 Carate Brianza - Italy
Ph. +39 0362 91601 - Fax +39 0362 990457
elysol.brianzaplastica.it/en/ - www.grp-sheets.com/en/
sales-grpbuilding@brianzaplastica.it



Quality Management
System
EN ISO 9001:2015
Certificate nr 106
O.U. Carate Brianza



ISO 9001:2015
CERTIFIED QUALITY
MANAGEMENT SYSTEM

The features and technical data contained in this catalog may be subject to changes without prior notice. For updated technical data and product data sheets, always refer directly to the company. Brianza Plastica also declines any responsibility deriving from incorrect use of the product, as the conditions of use are not under our direct control.